

DEPARTEMENT DU RHONE



Commune de  
**POULE-LES ECHARMEAUX**

---

**Délégation du Service Public de l'Eau Potable**

---

**Dossier de  
Consultation des  
Entreprises**

**Pièces n° 9**

**Plan**

# POULE LES ECHARMEAUX

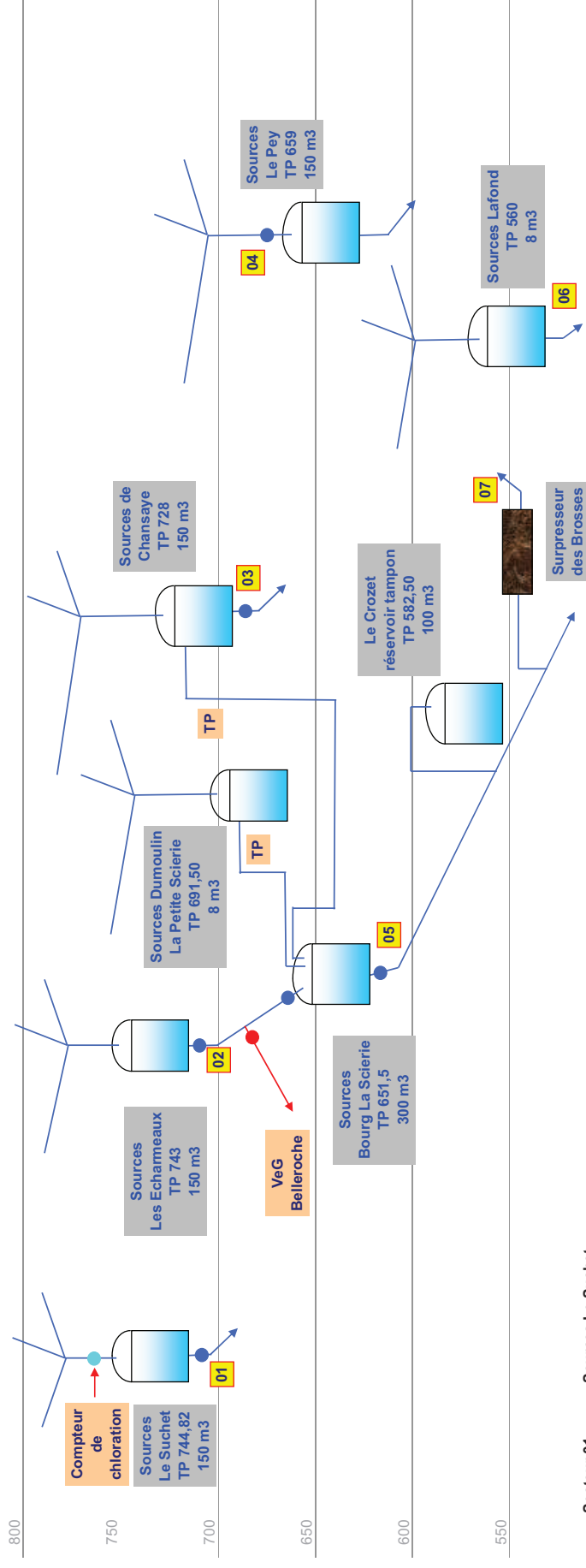





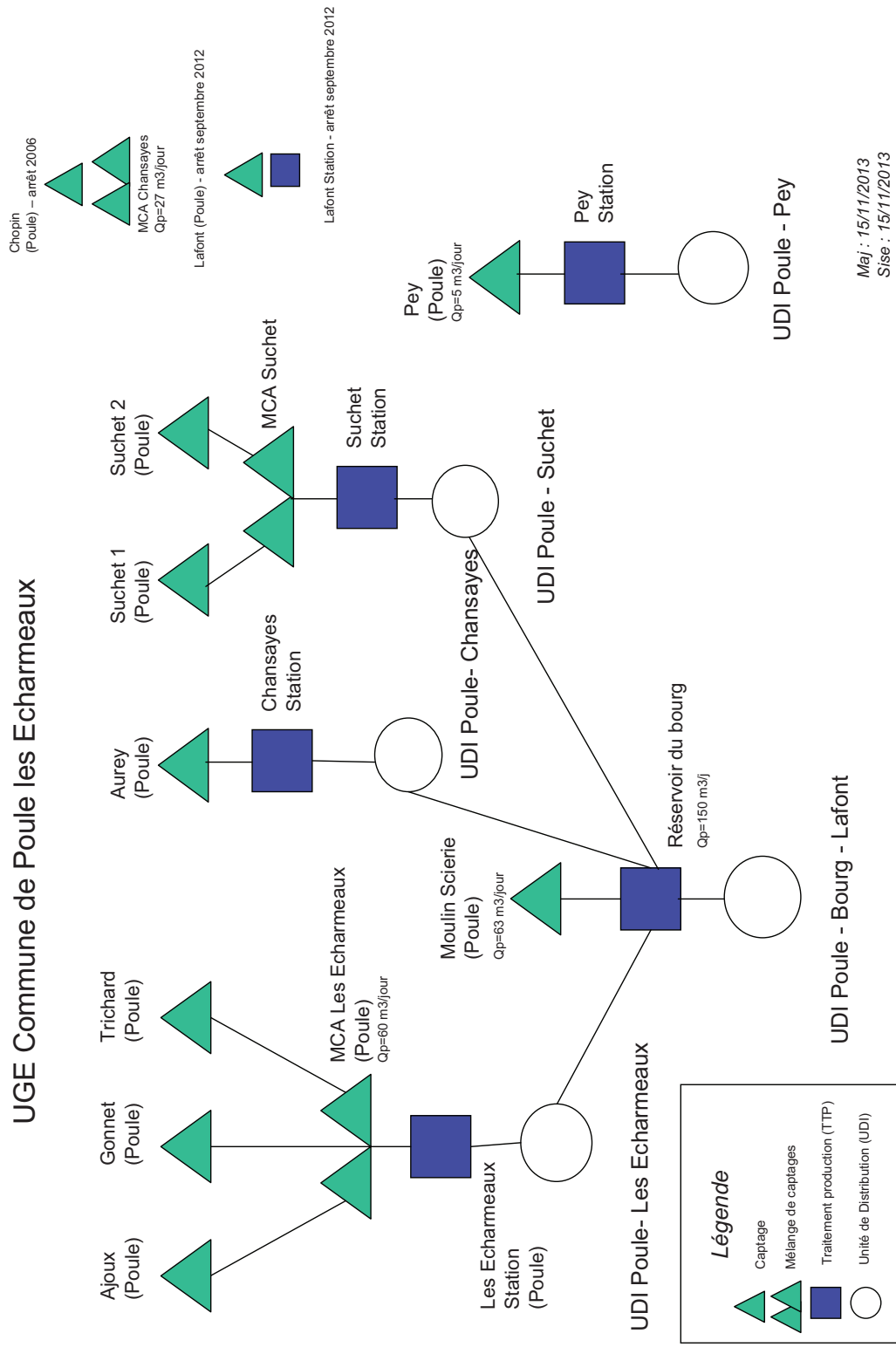



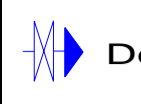
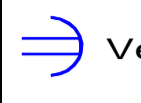
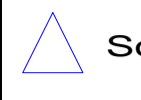





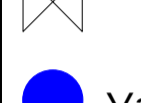
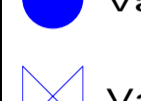
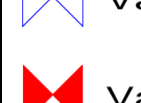

- Secteur.01 : Sources Le Suchet
- Secteur.02 : Sources Les Echarmeaux
- Secteur.03 : Sources de Chansaye
- Secteur.04 : Sources Le Pey
- Secteur.05 : Sources Le Bourg La Scierie + complément sources les Echarmeaux (à défaut) + TP sources Dumoulin et Chansaye
- Secteur.06 : Sources Lafond
- Secteur.07 : Surrsseur Les Brosses

## UGE Commune de Poule les Echarmeaux

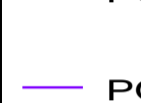

### Légende

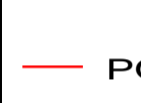
-  Appareil de mesure
-  Décharge
-  Ventouse
-  Source / Forage
-  Poteau incendie Ø=100mm
-  Poteau incendie Ø=80mm
-  Poteau incendie Ø=60mm
-  Station de refoulement
-  Régulateur de débit
-  Réducteur de pression
-  Stabilisateur de pression
-  Réservoir enterré ou semi-enterré
-  Station de Traitement
-  Vanne 1/4 tour
-  Vanne ouverte
-  Vanne fermée
-  POULE LES ECHARMEUX : SECTEUR PEY
-  POULE LES ECHARMEUX : SECTEUR SUCHET
-  POULE LES ECHARMEUX : SECTEUR LES ECHARMEUX
-  POULE LES ECHARMEUX : SECTEUR LES BROSSES
-  POULE LES ECHARMEUX : SECTEUR LE BOURG
-  POULE LES ECHARMEUX : SECTEUR CROZET
-  POULE LES ECHARMEUX : SECTEUR CHANSAYE
-  Conduite eau potable

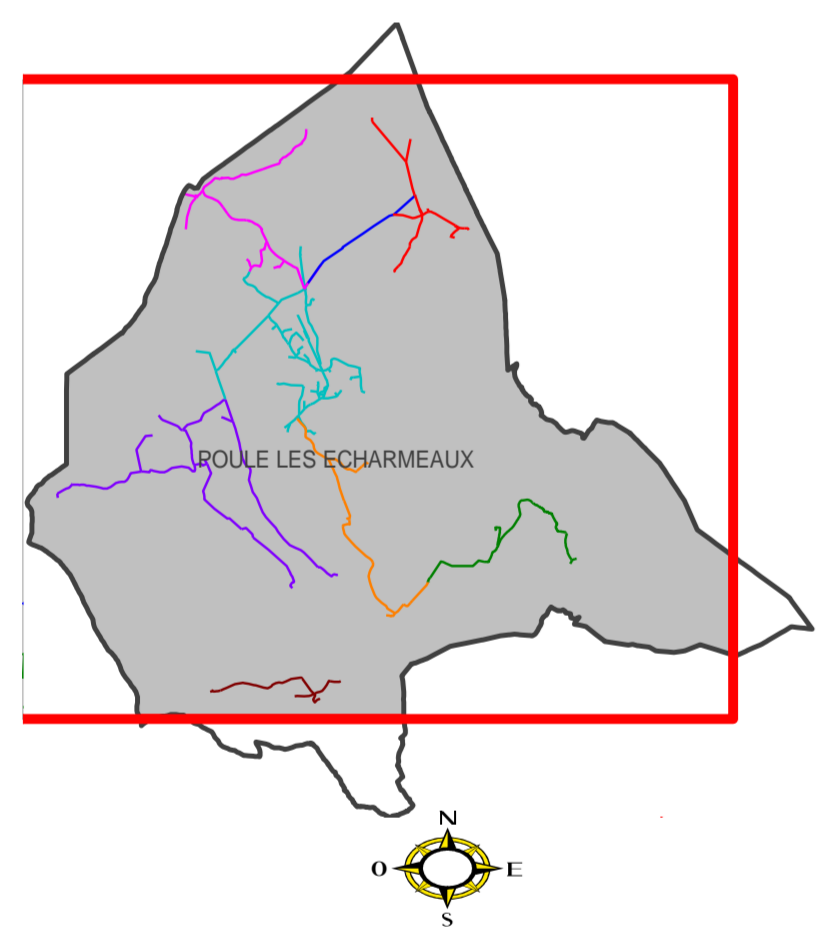

DEPARTEMENT DU RHONE

## POULE LES ECHARMEUX PLAN GENERAL

EAU - POULE LES ECHARMEUX

ALIMENTATION EN EAU POTABLE

ENTREPRISE REGIONALE RHONE ALPES AUVERGNE  
988, Chemin Pierre DREVET CS 20152  
69141 RILLIEUX-LA-PAPE Cedex

Planche: 1/1  
Echelle: 1/8000  
Date de Création:  
Dessinateur: RN  
Date d'édition: 03/02/2015

